

CC3748
Crossover Platform



CC3748 Crossover Package

PARTS LIST

ITEM	QTY	PART NUMBER	DESCRIPTION
1	1	CS-37048	Plate, Tread, Crossover Platform
2	2	CS-37010	Brace, Tread, Crossover Platform
3	4	CS-37020	Angle, Post, Crossover Platform
4	4	HRC1500	Handrail Clamp for 1.5 in
5	4	HRC1000	Handrail Clamp for 1 in
6	2	TR1003900	1" Midrail, 39" no swage
7	2	TR1503900	1.5" Handrail, 39" no swage

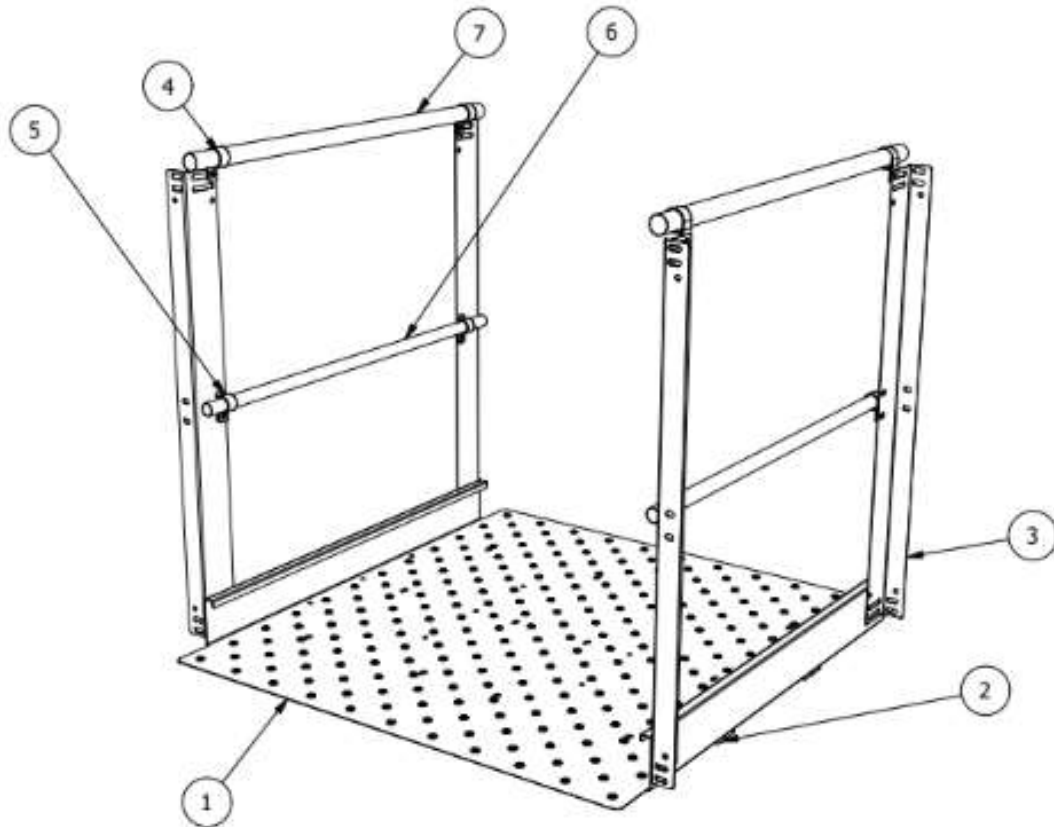

CC3748 Component Reference

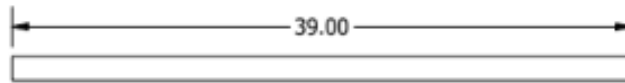

TR1503400

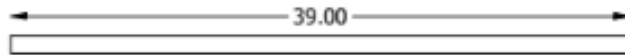

TR1004300

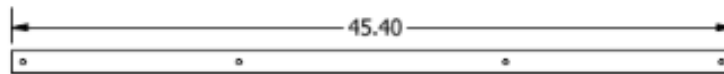

CS-37010

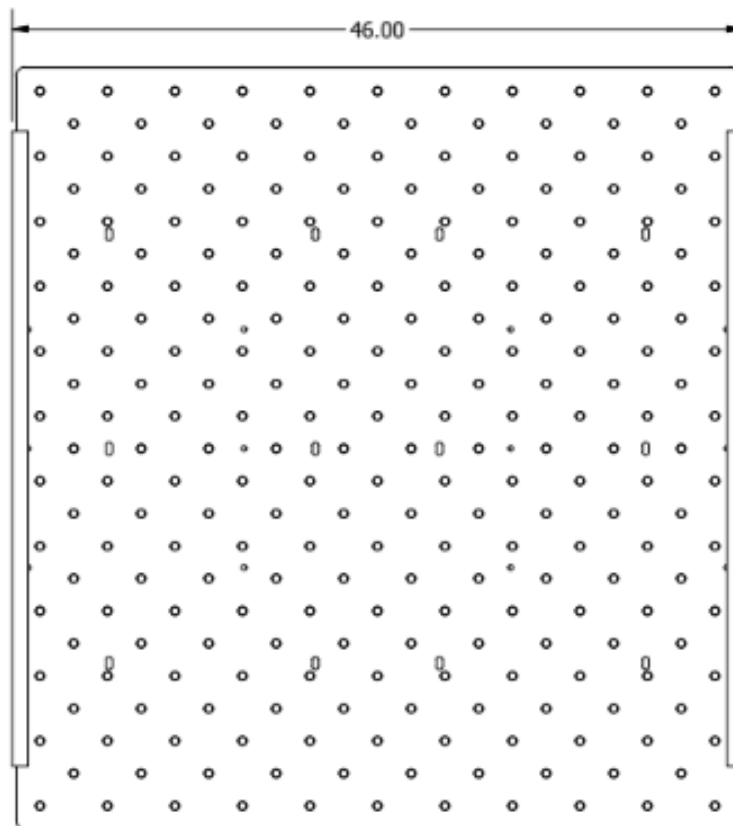

CS-37048

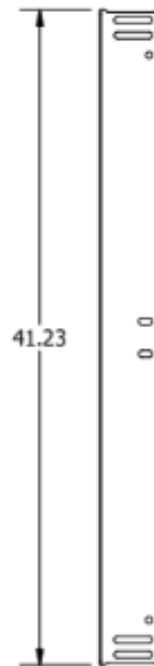

CS-37020

Bin Separation

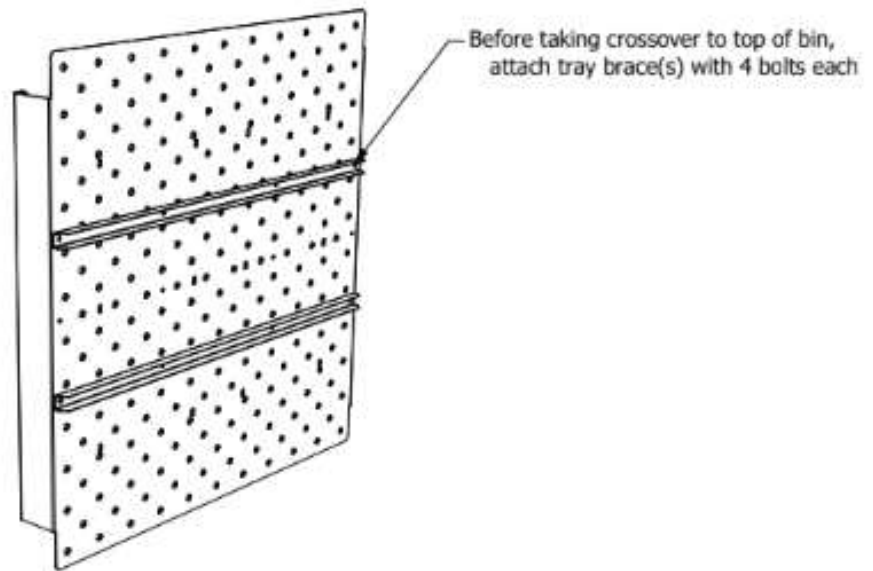

CC3748 Crossover Platform is designed for use with Easy Step or C-series top platforms. Depending on which system is installed, recommended bin separation (S) is slightly different.

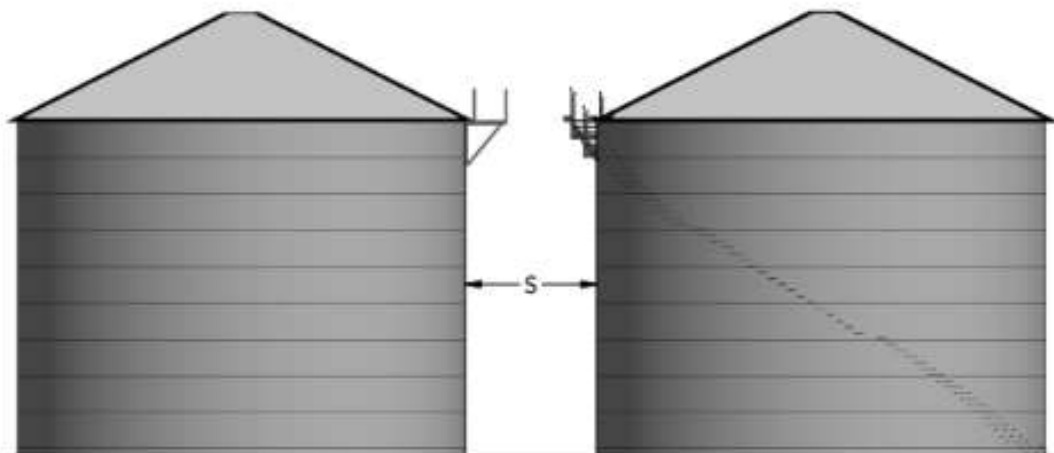
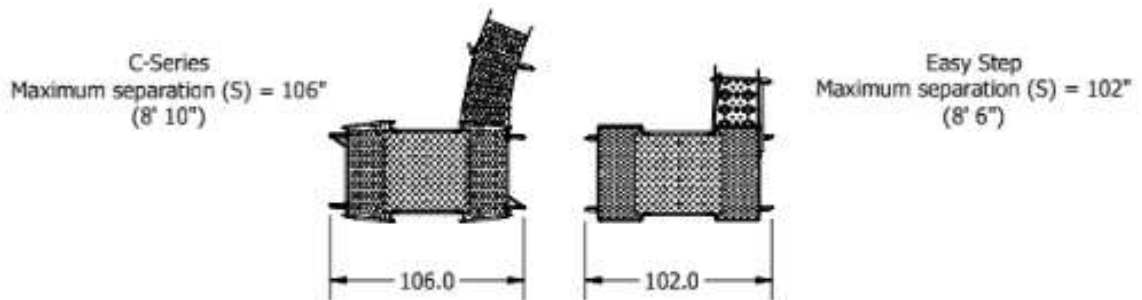

CC3748 with Easy Step Platforms

Set tray with brace so that it rests on the platforms at each end.
Attach posts to platform corner posts with the long side facing the tray as shown

Do not walk on crossover tray until it has been secured to at least one platform!

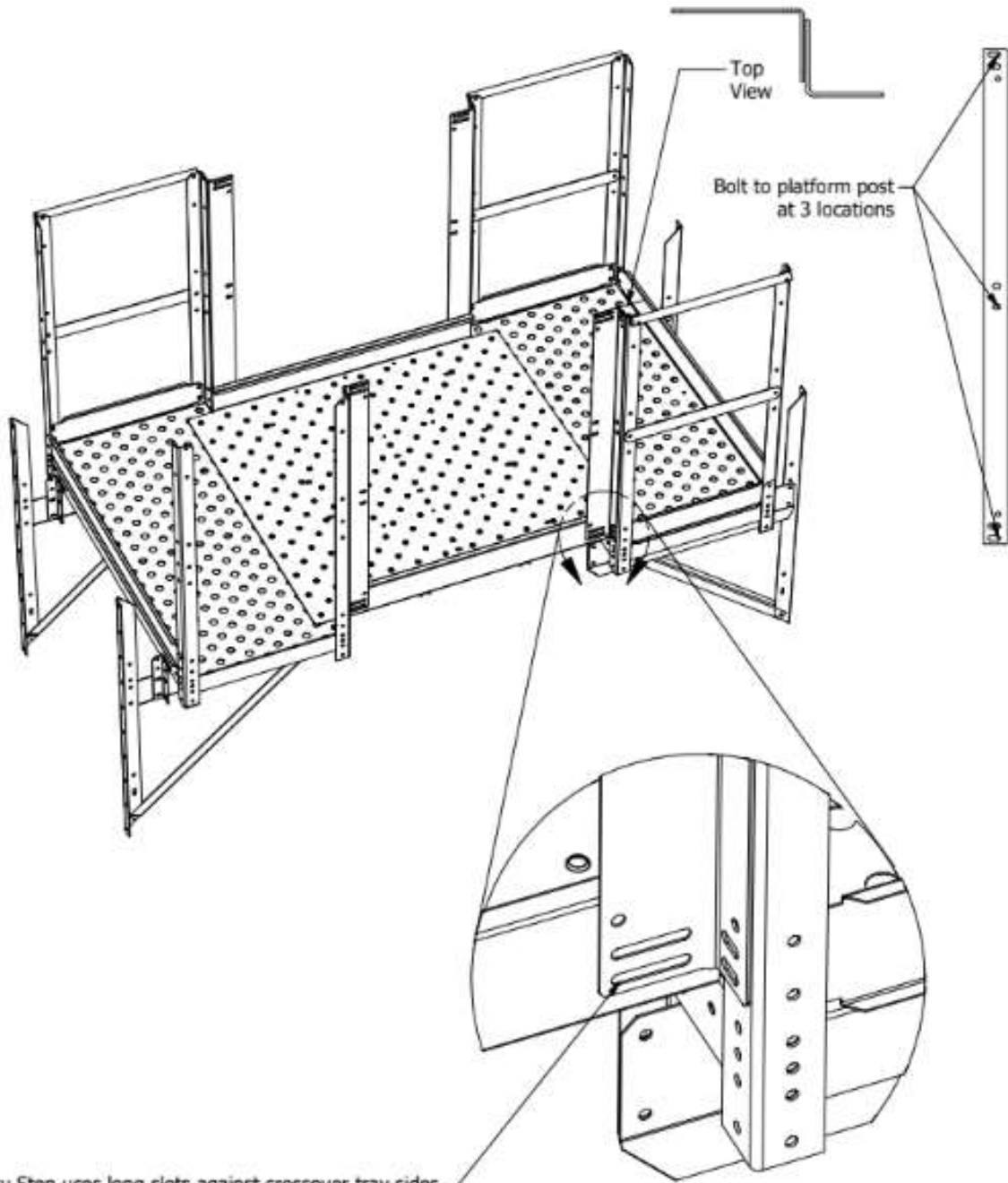

Easy Step uses long slots against crossover tray sides

CC3748 with C-Series Platforms

Set tray with brace so that it rests on the platforms on each end.
Attach posts to platform corner posts with the short side facing the tray as shown

Do not walk on crossover tray until it has been secured to at least one platform!

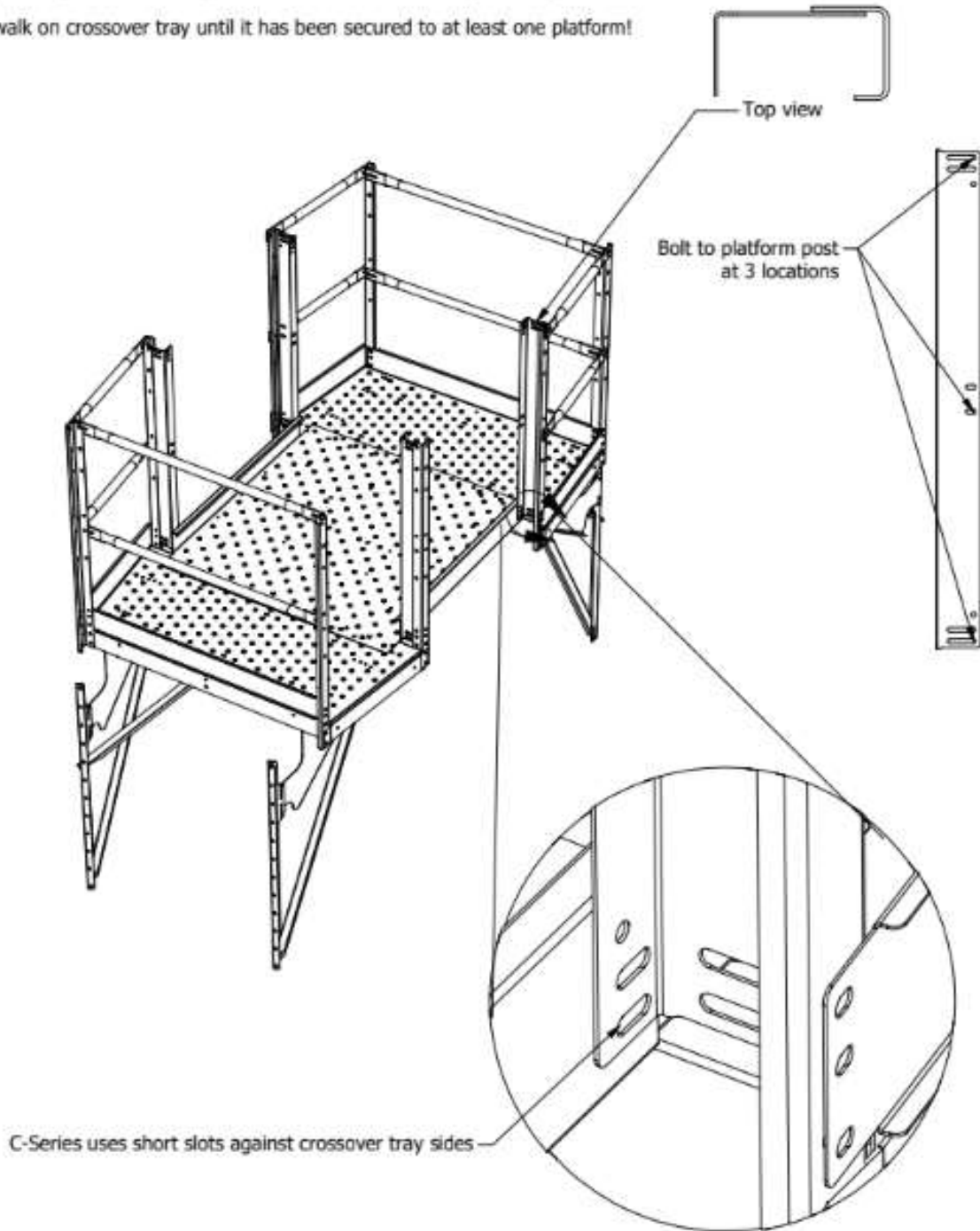

Secure Tray to Posts

Crossover tray should fully rest on both top platforms and toekick should not protrude into walking path. Drill holes at the center of each slot in the post extensions and bolt the tray to the posts.

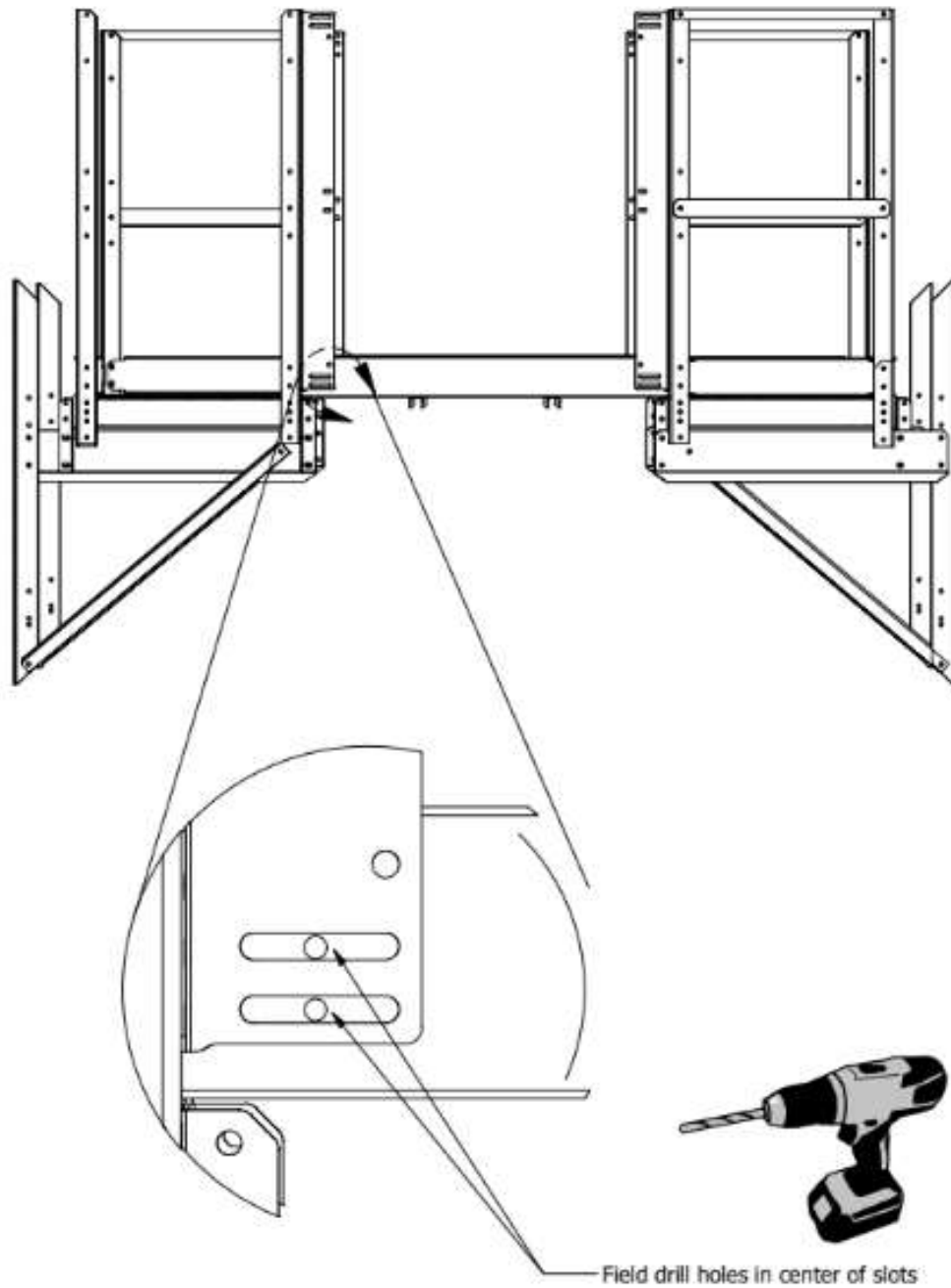

Attach Handrail

Bolt handrail clamps to the posts, insert tube rail and tighten.

1" Tube located at 21.5" (Midrail)

1.5" Tube located at 42.5" (Handrail)

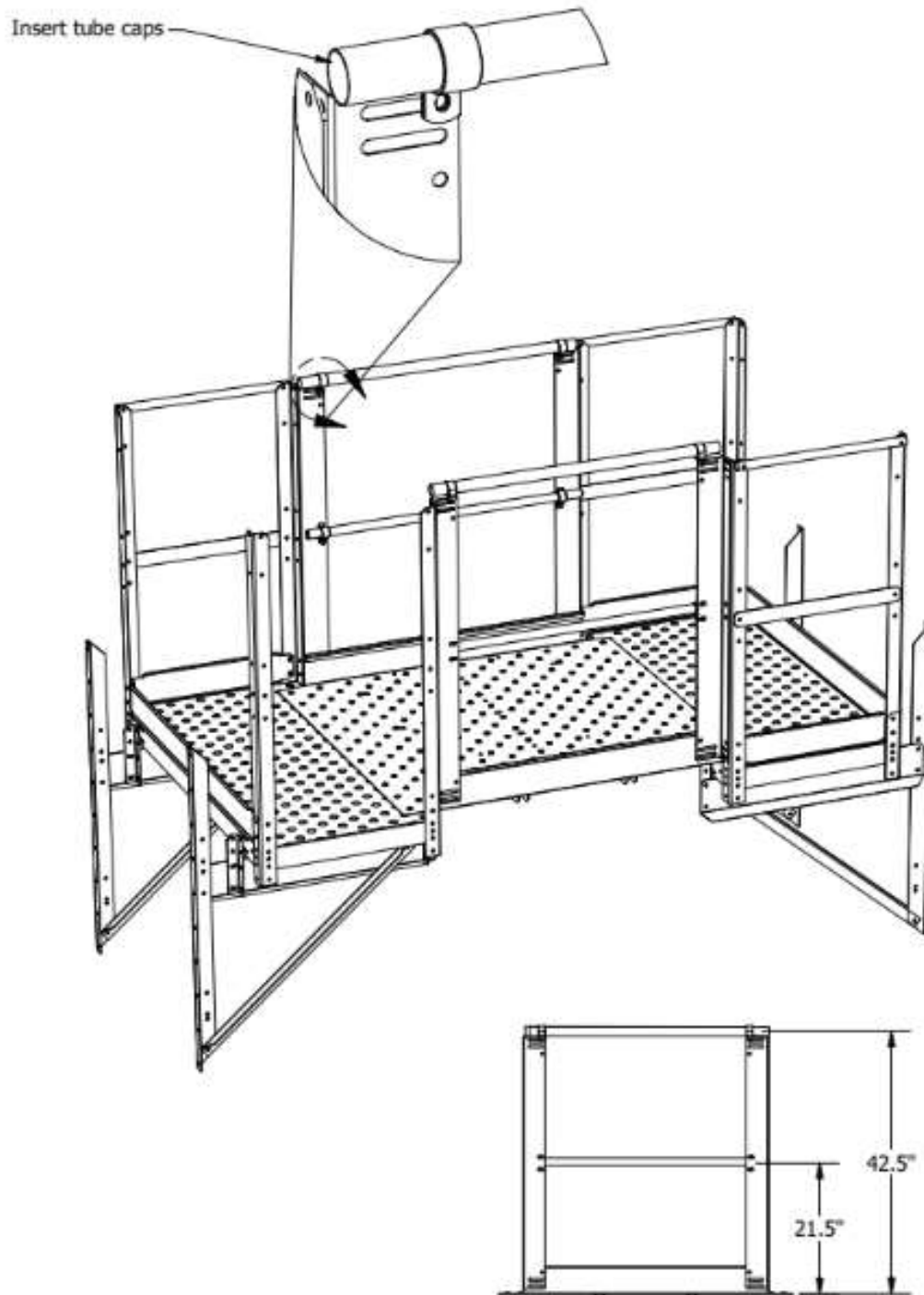

Attach Plates

Use the self-tapping floor screws to attach the crossover tray to the platform surfaces to prevent surface deformation

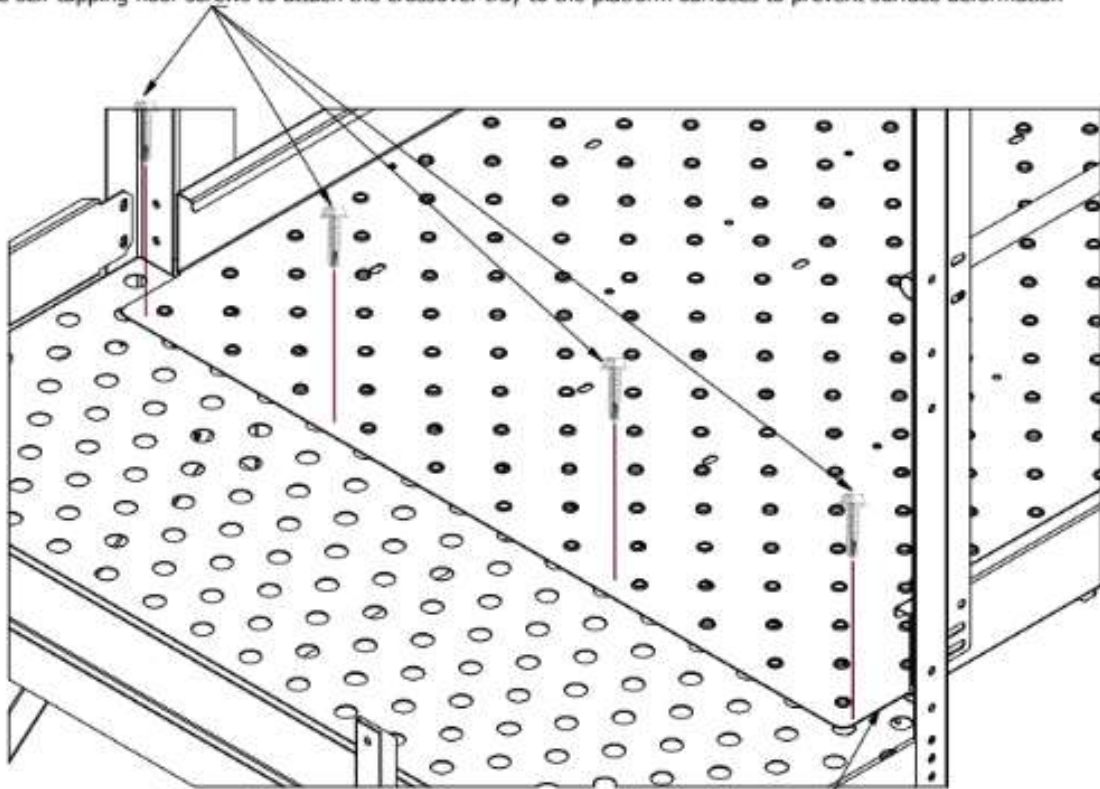

Trim excess toekick material if necessary
(side flanges should not protrude beyond platform post)

The Installation is complete

