

WMO102

10' Bin Wall Mounted Support
2-Stiffened Tank

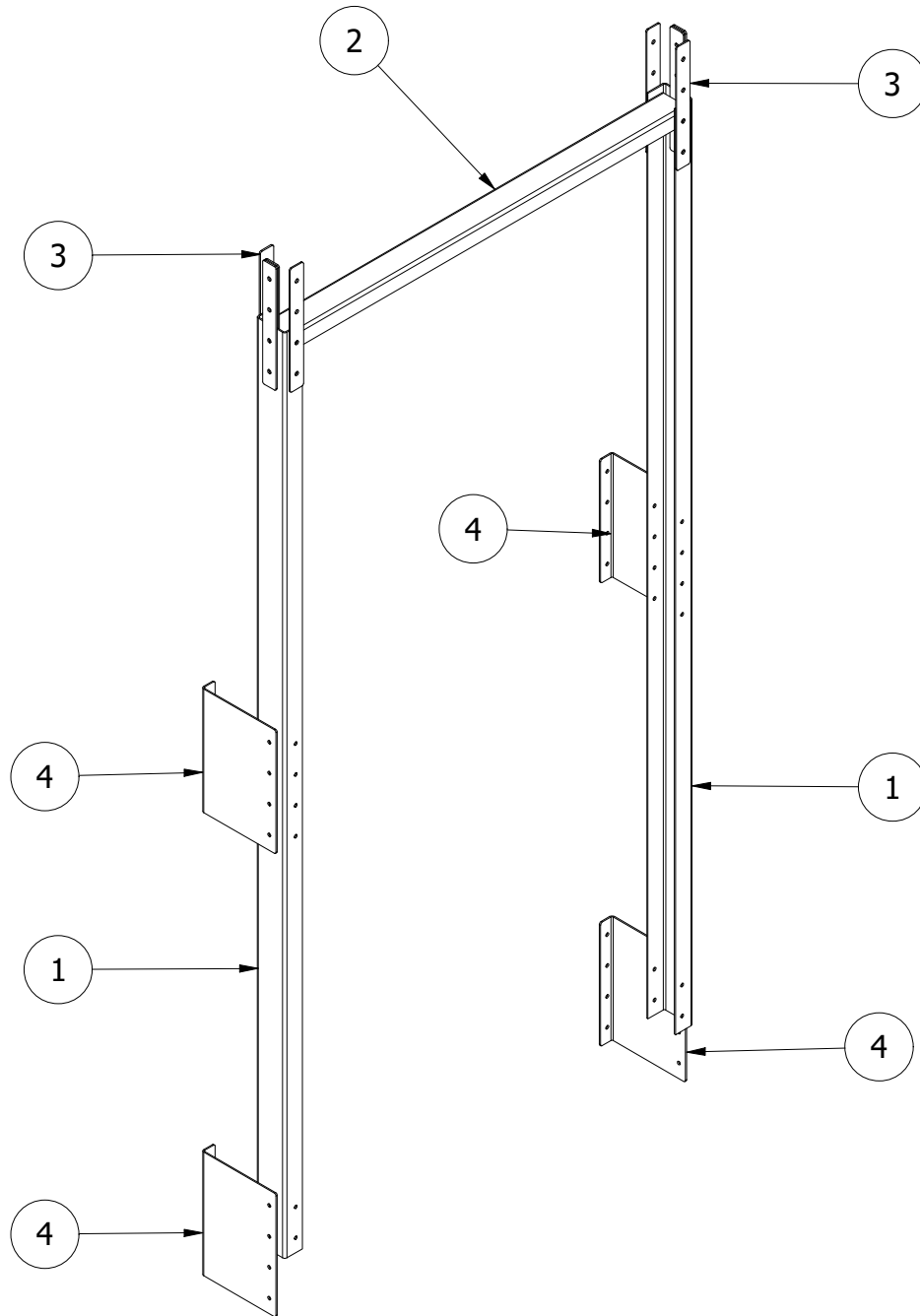

WMO102 PARTS LIST			
ITEM	QTY	PART NUMBER	DESCRIPTION
1	2	WMS12	Wall Mount Siderail
2	1	WCB02	Wall Cross Brace
3	8	WSP01	Wall Splice Plate
4	4	WMB04	Wall Bracket

WMO102

10' Bin Wall Mounted Support
2-Stiffened Tank

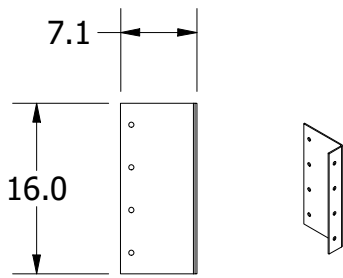
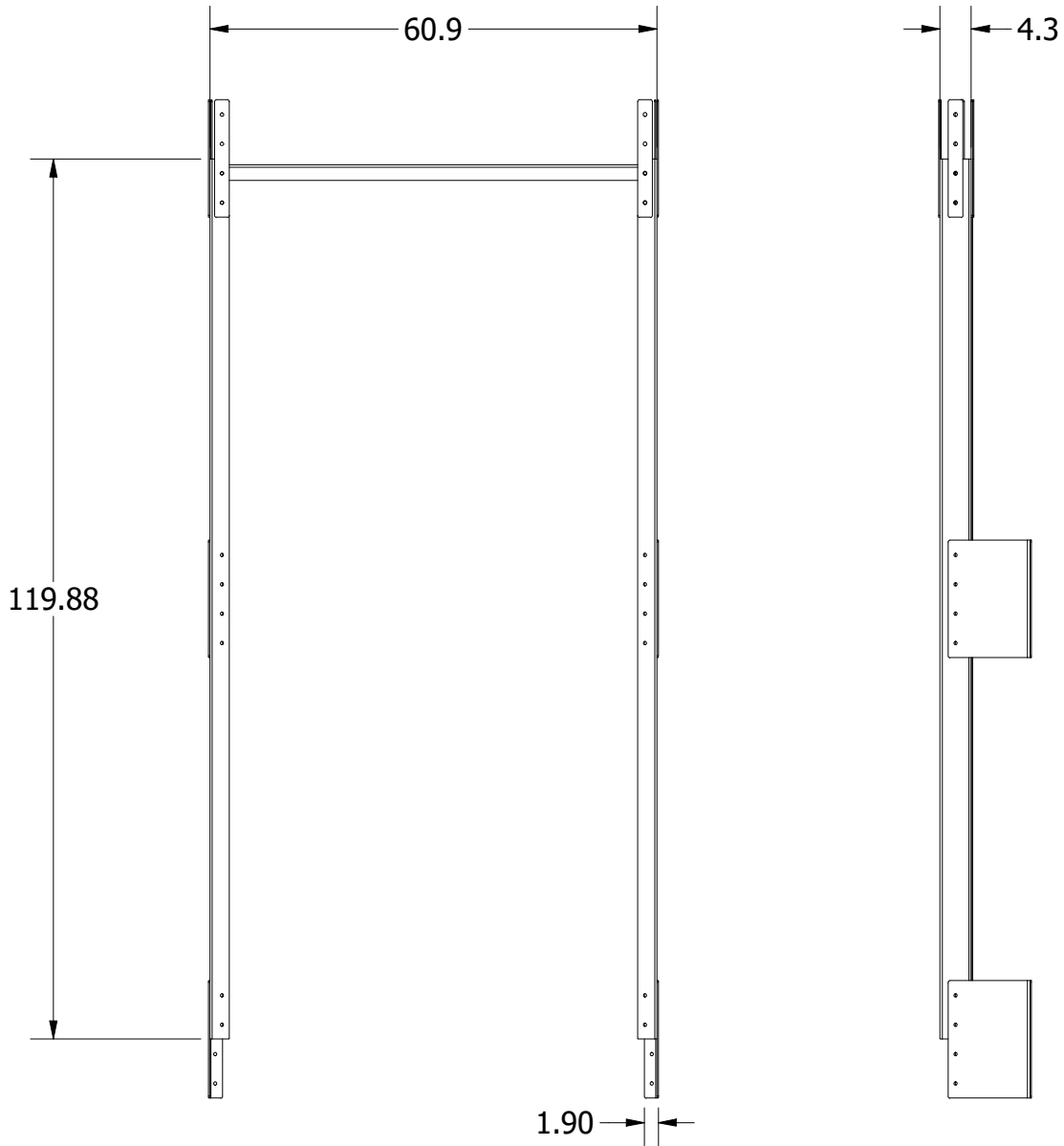

Optional
WMB02 Wall Bracket Short

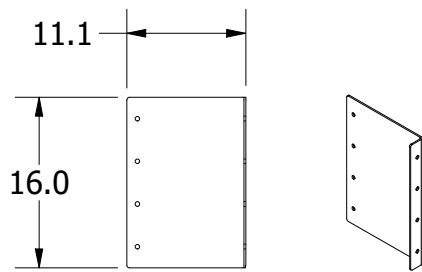

Standard
WMB04 Wall Bracket

WMO102
 10' Bin Wall Mounted Support
 2-Stiffened Tank

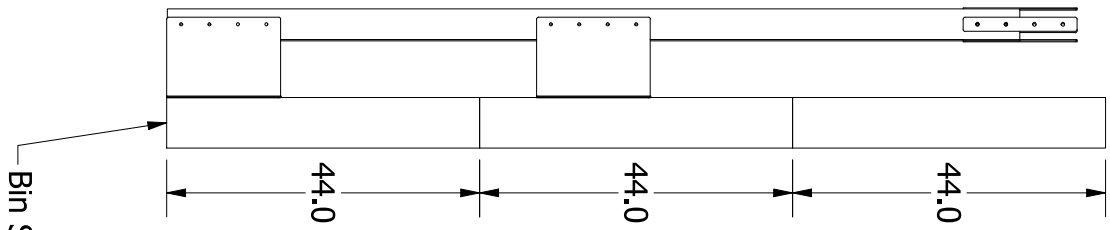

Bin Sidewall Ring Illustration

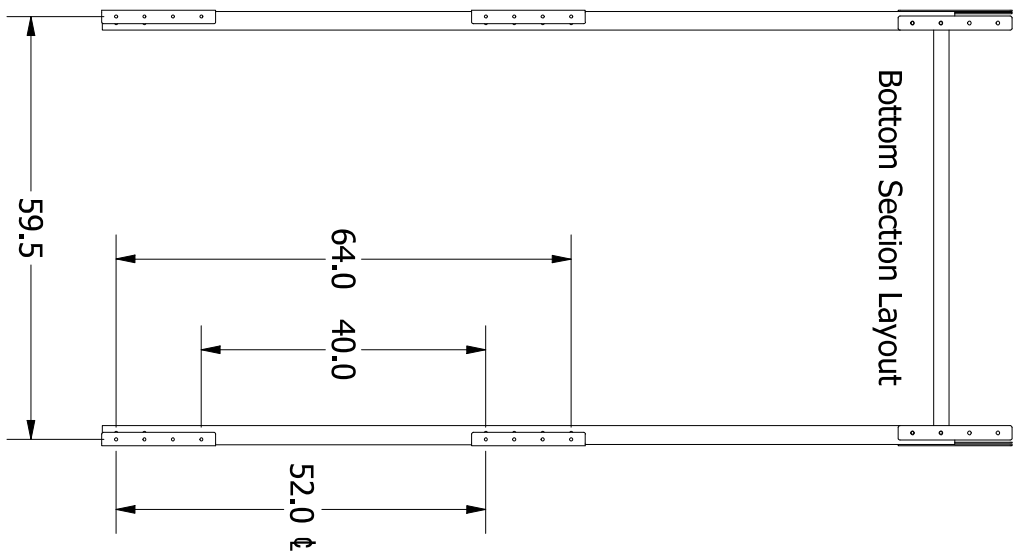

Bottom Section Layout

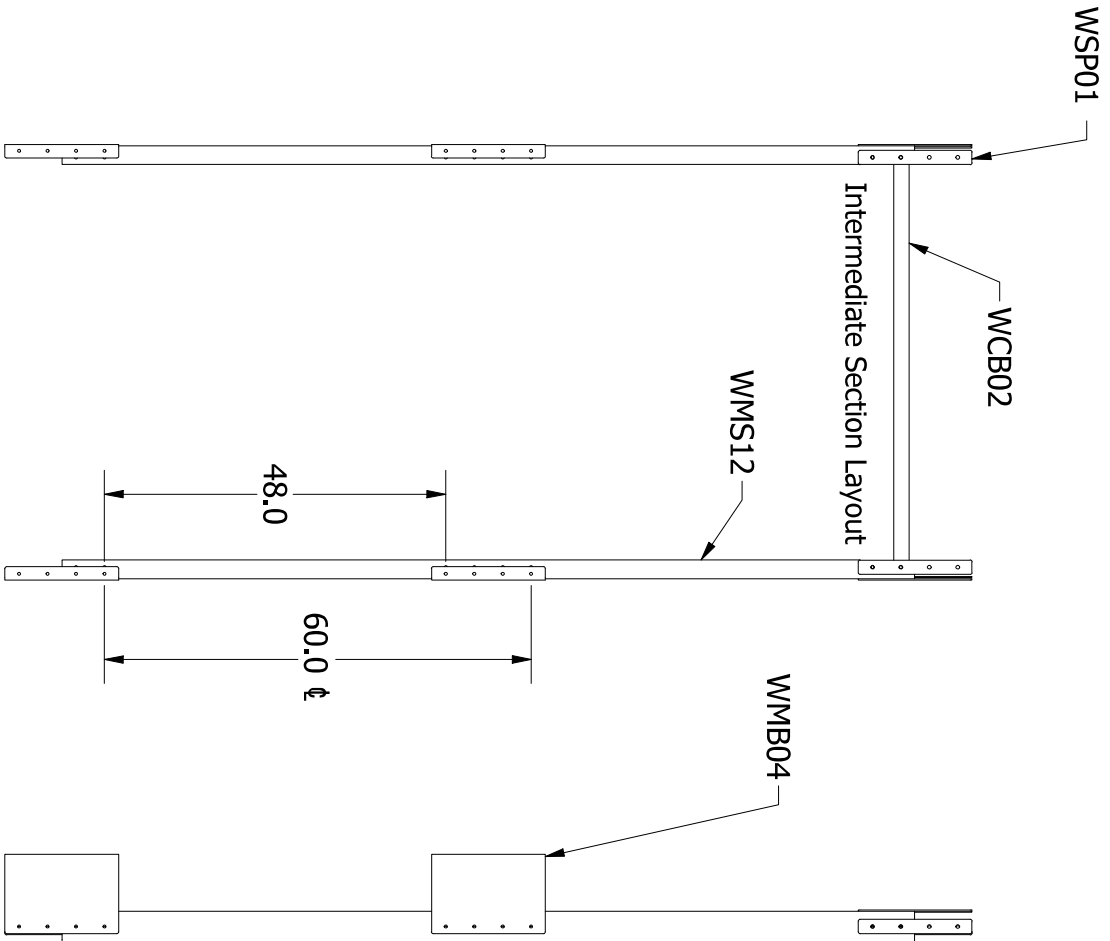

Intermediate Section Layout