

4

3

2

1

D

D

C

C

B

B

A

A

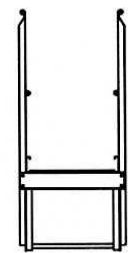
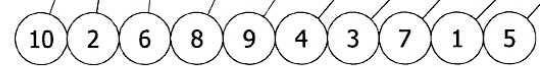
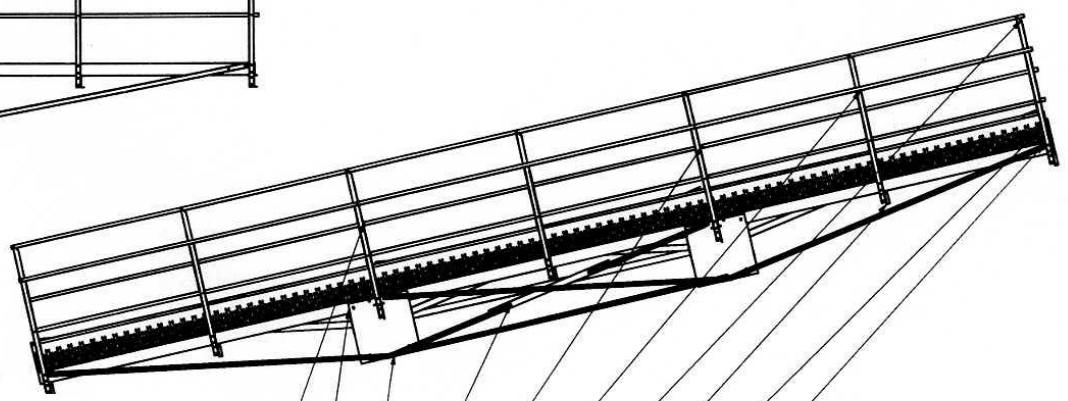
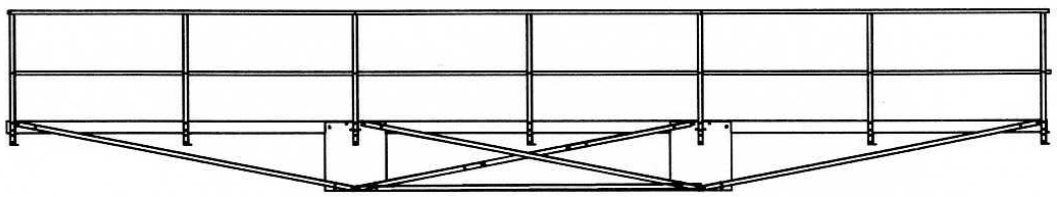

Parts List			
ITEM	QTY	PART NUMBER	DESCRIPTION
1	2	12 ga 120" manwalk	
	1	12 ga 144" manwalk	
2	4	6205 Truss Plate	
3	7	6206 Manwalk Post Right	
4	7	6207 Manwalk Post Left	
5	4	6210 10' Brace	
	4	6212 12' Brace	
6	4	6213 Plate Brace	
7	5	6208 Post Brace	
8	6	6312 Short 12' Brace	
9	8	HR1120 10' Handrail	
	4	HR1144 12' Handrail	
10	8	HRS185 Handrail Splice	

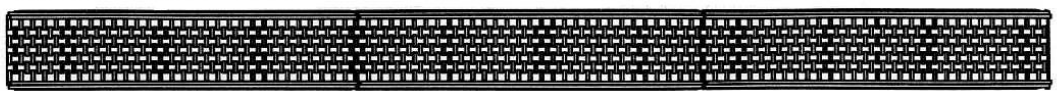

DRAWN Rex A Greene	8/1/2005	Greene Welding and Hardware Inc. Greene Galvanized Stairs 217/375/4244 www.greenebstairs.com	
CHECKED		TITLE IN-62006	
QA		SIZE C	REV
MFG		SCALE NA	32' Manwalk
APPROVED		SHEET 1 OF 1	

GREENE

WELDING & HDW., INC.

BOX 191 • EAST LYNN, IL 60932 • 217-375-4244

Galvanized Stairs

COMMERCIAL AND FARM

MANWALK INSTALLATION INSTRUCTIONS

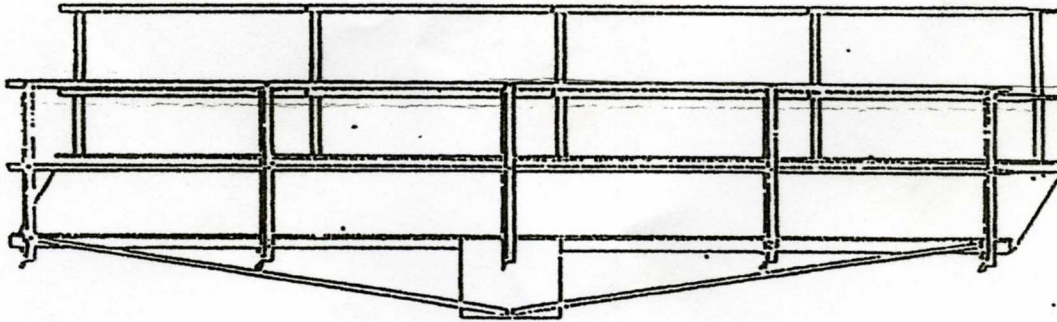

ASSEMBLED MANWALK

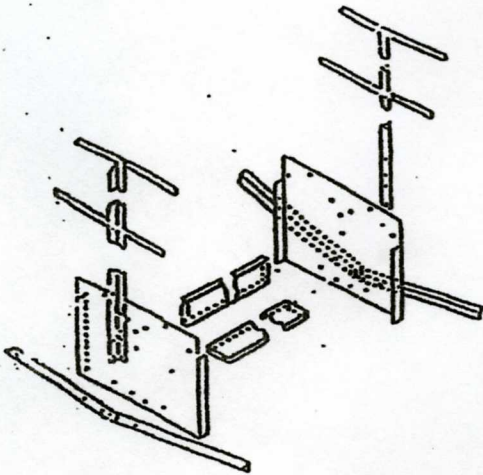

TRUSS PLATE ASSEMBLY

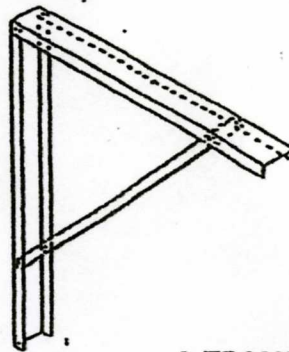

A-FRAME

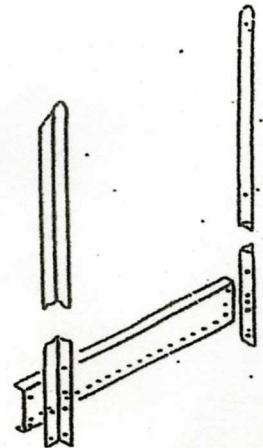

POST ASSEMBLY

Note: All holes in the walkway are to be field drilled

Assemble the truss plate assembly and fasten it to the walkway keeping the two pieces of walkway straight. Find the desired length of the walkway, if cutting is required, cut equally from both ends of the walkway. Mount a post assembly 6" from each end of the walkway (if the end of the walkway is cut at an angle, the post assembly should be 6" from the shorter side of the walkway leaving 6" plus on the other side). Fasten one end of the truss brace to the truss plate assembly and the other end mounts next to the end post assembly, some cutting may be necessary. Place the intermediate post assembly between the end post assembly and the truss plate assembly sliding it toward the end post assembly and fasten unit to the walkway where it touches the truss brace. When fastening the handrails to the post use TEK screws keeping the splices of the handrails on the post (some cutting may be necessary).

Center section of the three section Manwalk

